

Operating instructions

# VX 26 H 0650

# VX 29 H 0650

Local/Remote feed distribution amplifier



Connecting past,  
present and future.

[wisigroup.com](http://wisigroup.com)

## Stay up to date



For more information on your device, visit our support-website:

[www.wisiconnect.tv](http://www.wisiconnect.tv)

After logging in/registering, you will have access to a variety of interesting information and features, such as release notes or installation examples.

# Table of Contents

## Important information

<b>1 About this document.</b>	<b>4</b>
1.1 Structure of warnings	4
1.2 Structure of action steps.	4
1.3 Other symbols	4
<b>2 Safety instructions.</b>	<b>5</b>
2.1 General safety instructions	5
2.2 Intended use	5
2.3 Improper use	5
2.4 Specialist personnel	5
2.5 Disposal	5
2.6 Electrical safety	6
2.7 ESD protection.	6
<b>3 Overview</b>	<b>7</b>
3.1 Powering options	7
3.2 RF connectors	7
3.3 Outer features	8
3.4 Technical data	9
<b>4 Installation</b>	<b>11</b>
4.1 VX 26 H 0650	12
4.2 VX 29 H 0650	13

# Important information

## 1 About this document

These operating instructions are part of the device.



If the warnings, notes and instructions in this document are not followed, WISI does not assume any warranty or liability for safe operation and function of this device.

If not indicated otherwise, German is the original language. Other languages are translations of the original language.

### 1.1 Structure of warnings

Warnings indicate the possible risk of personal injury.

The warnings are always structured as follows:



#### SIGNAL WORD

##### Type and source of danger

Consequences of non-compliance

1. Measures to avoid

Four levels are differentiated with the signal word:

#### **DANGER**

Immediately serious injuries or death

#### **WARNING**

Possible serious injuries or death

#### **CAUTION**

Possible minor injuries

#### **ATTENTION**

Comprehensive property damage

### 1.2 Structure of action steps

Instructions for use can begin with an introductory text describing the following objectives. Then follow the action steps, which always start with a numbering.

Safe operation of the device can only be guaranteed if all action steps are carried out step by step.

1. This is an example of the first step.
2. This is an example of the second step.

### 1.3 Other symbols



Notes on damage to property and economic use are listed behind this symbol.

## 2 Safety instructions

### 2.1 General safety instructions

The device has been designed and constructed in such a way that hazards have been excluded as far as possible. Nevertheless, there may be residual risks.

- Before commissioning, familiarize yourself with this manual.
- Check the device carefully for obvious damage. Do not use damaged device! In this case, please contact your WISI representative.

### 2.2 Intended use

The device may only be used for the installation of HFC networks up to 1006 MHz.

### 2.3 Improper use

Any other use will result in the loss of warranty or guarantee.

WISI is not liable for any damages resulting from this. The user bears the sole risk.

### 2.4 Specialist personnel

#### 2.4.1 Assembly and repair

- Installation, repair, alternations, reajustments and upgrades may only be carried out by authorised specialists.

#### 2.4.2 Operation

- Work on the unit may only be carried out by authorised specialists.

### 2.5 Disposal



The unit must be disposed of properly.

Within the European Economic Area, the device must be disposed of in accordance with EU Directive 2012/19/EU (WEEE).

1. If you have any questions about the proper disposal of waste electrical equipment, please contact the responsible local authority, the recycling centre or the specialist dealer.

## 2.6 Electrical safety

- The local mains voltage must correspond to the specified supply voltage of the device.
- Carry out work on the device in accordance with the local safety regulations.
- Observe the safety regulations of the current standards EN 60728-11 and EN 62368-1 or the national standards.
- Factory mounted covers inside of the device (e.g. power supply protection cover) must not be removed. When making adjustments, only operate the elements that are intended to be adjusted.
- Replace damaged cables and connectors immediately.
- The mains cable must be installed in a loop so that any condensation or perspiration water can drip off and not get inside the device.
- Connect the unit to a potential equalisation system in accordance with the locally applicable electrical standards.
- Device does not have a main switch. As soon as the device is plugged in, it is in operation. In order to turn off the power supply, the mains plug must be removed from the mains socket. Mains socket must be easily accessible so that the mains plug can be pulled quickly if necessary.



Always pull the plug.

Never pull the cable.

- The power supply area of the device as well as all coaxial interfaces with remote power supply carry dangerous voltages.
- Dangerous live parts must not be touched.
- The device may only be installed and put into operation in a dry room.
- Do not expose the device to splash water or other liquids. Do not place liquids on the device.
- Do not mount the device on or near flammable materials.
- Never operate the device without a lid/protective cover.

## 2.7 ESD protection

The device contains components that are sensitive to electrostatic discharges. In case of improper handling, the device may be damaged, e.g. during unpacking, assembly/disassembly, storage or shipping.



A harmful discharge can happen unnoticed.

Always take the usual protective measures when handling the device.

### 3 Overview

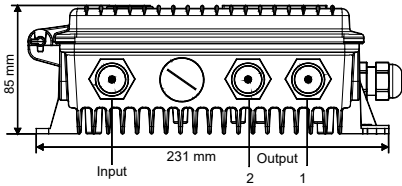

Dimensions VX 26 H 0650

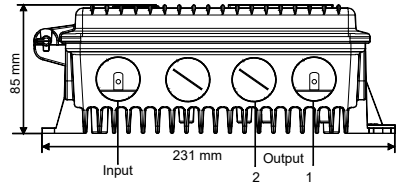

Dimensions VX 29 H 0650

- Aluminium die-cast housing
- Screwed, folding cover
- Integrated upstream amplifier and diplexer
- All settings via defined switching steps (Q-step) or jumper
- Output splitter (pluggable)
- Lightning protection of all RF-connections

#### 3.1 Powering options

WISI type	Supply voltage
VX 26 H xxxx	180...265 VAC
VX 29 H xxxx	27...90 VAC

#### 3.2 RF connectors

WISI type	Description
ZG 27	PG 11 case connection for WISI MK 15 cable
ZG 28	PG 11 adapter, F female
ZG 35 A	PG 11 adapter, 3.5/12 female

### 3.3 Outer features

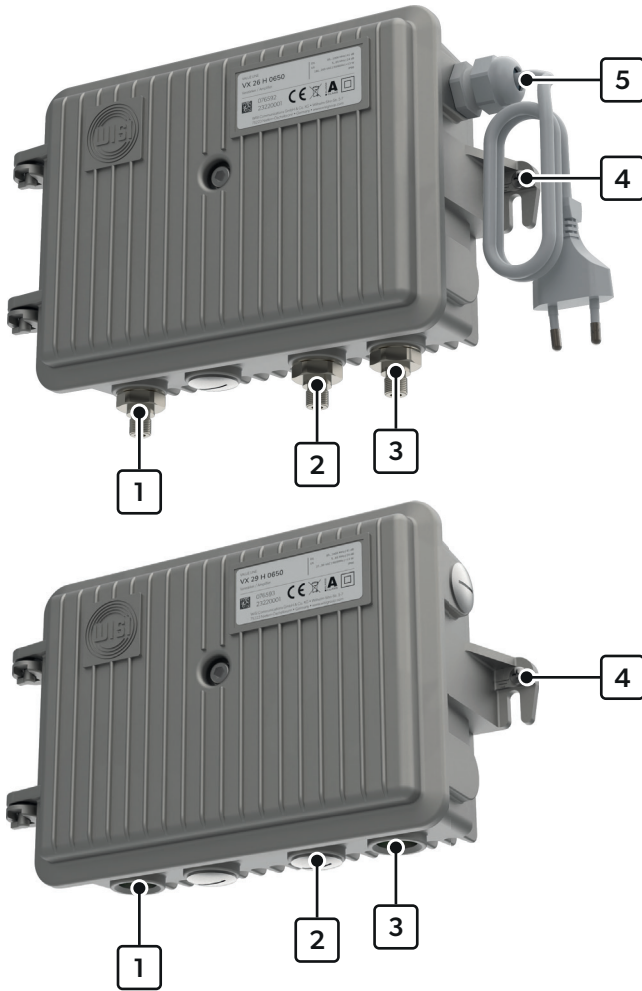

- 1 Input
- 2 Output 2
- 3 Output 1
- 4 GND terminal
- 5 Mains input



### 3.4 Technical data



The latest technical data can be found on the Internet at [www.katalog.wisi.de](http://www.katalog.wisi.de).

Downstream	
Frequency range	85...1006 MHz
Return loss	$\geq 18$ dB (-1 dB/Oct.)
Noise figure	$\leq 6,0$ dB
Gain	41 dB
Frequency response	$\leq \pm 0,5$ dB (85...862 MHz) $\leq \pm 0,75$ dB (862...1006 MHz)
Input attenuator	0...15 dB
Step size	1 dB
Input equalizer	0...22,5 dB
Step size	1,5 dB
Interstage equalizer (Jumper)	0/3/6/9 dB
Interstage attenuator (Jumper)	0/5 dB
Output level 1 CENELEC 42 Ch. flat, CSO, CTB $\geq 60$ dB	112 dB $\mu$ V
Output level 2 CENELEC 42 Ch. 6 dB slope, CSO, CTB $\geq 60$ dB	115 dB $\mu$ V
Output level 3 all QAM (112 x 256 QAM) flat	107 dB $\mu$ V
Output level 4 all QAM (112 x 256 QAM) 12 dB slope	109 dB $\mu$ V
RF test point output (Coupler)	-20 dB
RF test point input (Resistor)	-20 dB

### Upstream

Frequency range	5...65 MHz
Return loss	≥ 18 dB (-1 dB/Oct.)
Noise figure	≤ 6,0 dB
Gain	24 ± 0,5 dB
Frequency response	≤ ± 0,5 dB
Input/Output attenuator	0...15 dB
Step size	1 dB
Interstage attenuator (Jumper)	0/5 dB
Interstage equalizer (Jumper)	0/3/6/9 dB
Output level 1 BER ≤ 1E-8, MER ≥ 35 dB (6 x 64 QAM)	109 dBμV
Output level 2 NPR (< 50 dB) max. input level (60 MHz load)	14,7 dBμV/Hz, 24 dB dyn. range
Passive upstream	settable by jumpers
RF test point output (Resistor)	-20 dB

### General Specifications

Impedance	75 Ohm
RF connectors	
VX 26:	F
VX 29:	PG 11
Supply voltage	
VX 26:	180...265 VAC
VX 29:	27...90 VAC
Remote power current (VX29 only)	< 7 A
Operation indicator	LED green
Surge protection power supply	2 kV, EN 61000-4-5 1,2/ 50 μs pulse
Power consumption	typ. 13 W
Ambient temperature	-20°...+55°C
Storage temperature	-25°...+75°C
Protection class	IP 66
EMC	EN 50083-2
Surge protection power supply	2 kV, EN 61000-4-5 1,2/ 50 μs pulse
Lightning arrestor RF connectors	4 kV, EN 61000-4-5 1,2/ 50 μs pulse
Dimensions W x H x D	
VX 26:	240 x 158 x 80 mm
VX 29:	220 x 145 x 80 mm

## 4 Installation

There are two main powering concepts, depending on your amplifier type as shown in the following block diagram:

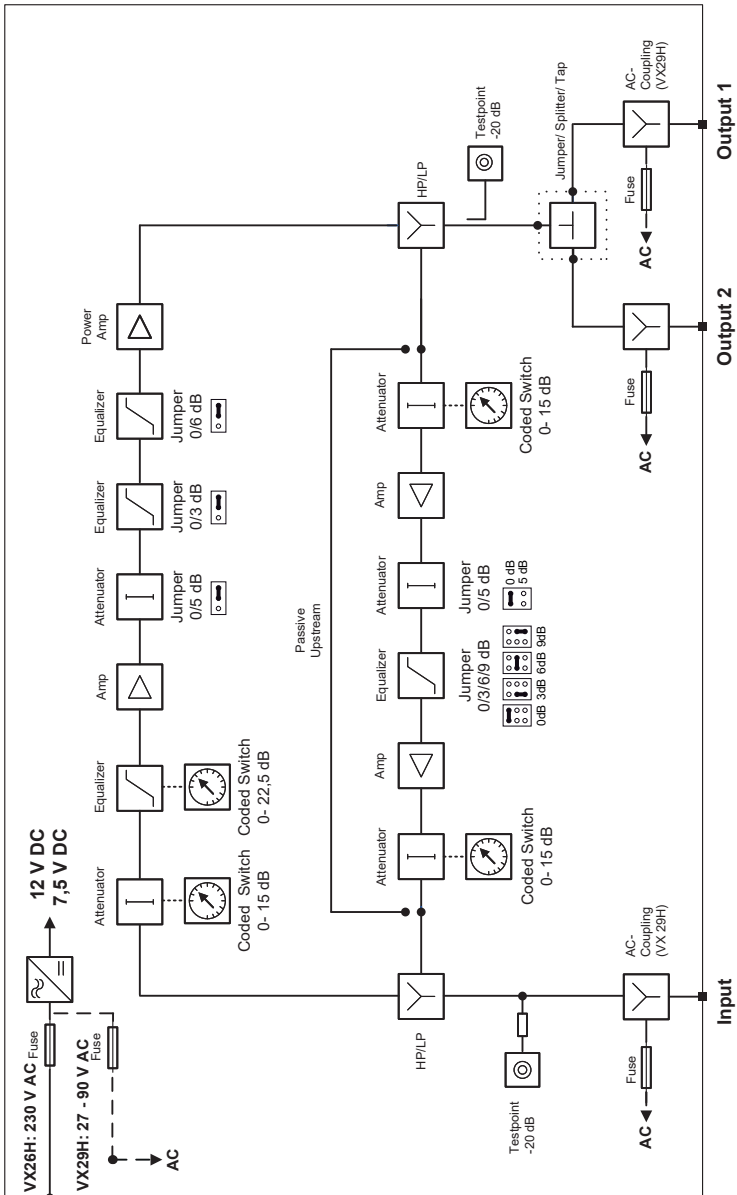

## 4.1 VX 26 H 0650

The VX 26 H 0650 is fed locally from 180...265 VAC mains and is equipped with a standard Europlug power cord.



### DANGER

#### Injuries due to electric shock

1. Never touch live parts.
2. Never remove factory mounted covers inside of the device (e.g. power supply protection cover).



The device contains components that are sensitive to electrostatic discharges. Always take the usual protective measures when handling the device.

1. Connect the unit to a potential equalisation system in accordance with the locally applicable electrical standards. For this purpose, the position marked with  must be used.
2. Loosen the cover screws and open the cover.
3. Plug the mains plug into the socket.

When the device is supplied with power, the power indicator LED lights up green.



4. Adjust the amplifier with attenuator and equalizer in accordance of the level plan.
5. Close the cover and tighten the cover screws (2 Nm +0,5 Nm).

## 4.2 VX 29 H 0650

The VX 29 H 0650 is fed remotely from 27...90 VAC. Remote powering can be engaged from the RF Input by plugging the according fuse. Power supply can be forwarded to next amplifier by plugging in fuses into corresponding sockets.



### DANGER

#### Injuries due to electric shock

1. Never touch live parts.
2. Never remove factory mounted covers inside of the device (e.g. power supply protection cover).



The device contains components that are sensitive to electrostatic discharges. Always take the usual protective measures when handling the device.

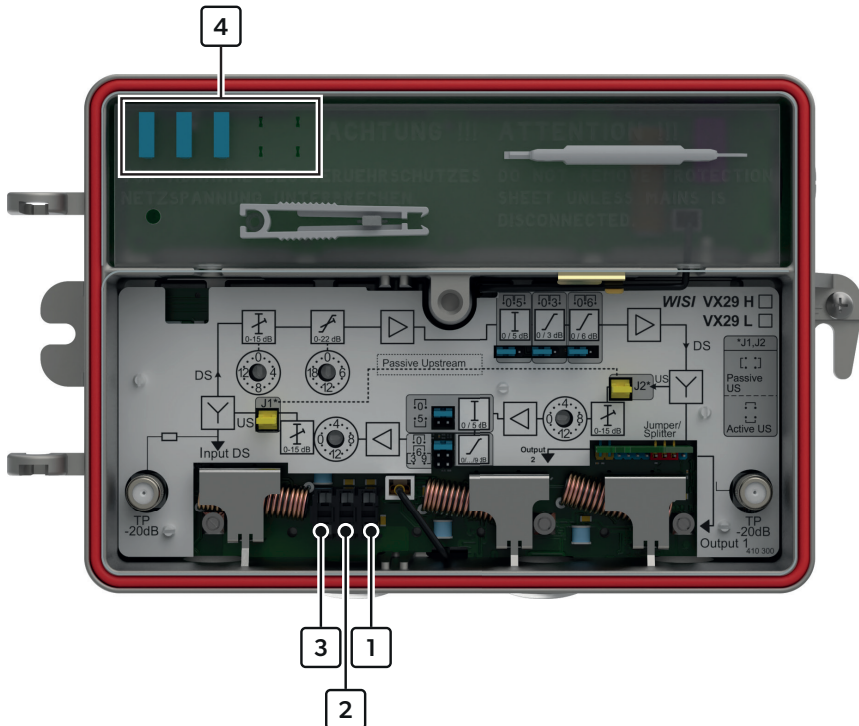

- 1 Fuse socket Output 1
- 2 Fuse socket Output 2
- 3 Fuse socket Input
- 4 Fuses

1. Connect the unit to a potential equalisation system in accordance with the locally applicable electrical standards. For this purpose, the position marked with  must be used.
2. Loosen the cover screws and open the cover.
3. For supplying the device with remote power, plug a fuse in the „Fuse socket Input“ (Pos.3)  
When the device is supplied with power, the power indicator LED lights up green.



4. Adjust the amplifier with attenuator and equalizer in accordance of the level plan.
5. To forward the remote power, plug a fuse in the „Fuse socket Output 1“ (Pos. 1) or „Fuse socket Output 2“ (Pos. 2), depending on the used Output.
6. Close the cover and tighten the cover screws (2 Nm +0,5 Nm).





416522-b

© WISI Communications GmbH & Co. KG. Technical Modifications reserved. WISI cannot be held liable for any printing error.



**WISI Communications GmbH & Co. KG**  
Wilhelm-Sihn-Str. 5-7  
75223 Niefern-Öschelbronn, Germany  
Fon: +49 7233 66 0  
info@wisigroup.com

[wisigroup.com](http://wisigroup.com)